



California Health and Human Services

Data Exchange Framework Stakeholder Advisory Group

Meeting #1

Tuesday, August 31, 2021
9:30 a.m. to 12:00 pm

Meeting Participation Options

Written Comments.

- Participants may submit comments and questions through the **Zoom Q&A box**; all comments will be recorded and reviewed by Advisory Group staff.
 - *Advisory Group Members* may also use the **panelist chat box** to submit comments and questions (send to “All Panelists”).
- Participants may also submit comments and questions - as well as requests to receive Data Exchange Framework updates - to CDII@chhs.ca.gov.

Meeting Participation Options

Spoken Comments.

Participants and *Advisory Group Members* must “raise their hand” for Zoom facilitators to unmute them to share comments; the Chair will notify participants/Members of appropriate time to volunteer feedback.

If you logged on via phone-only

Press “*9” on your phone to “raise your hand”

Listen for your phone number to be called by moderator

If selected to share your comment, please ensure you are “unmuted” on your phone by pressing “*6”

If you logged on via Zoom interface

Press “Raise Hand” in the “Reactions” button on the screen

If selected to share your comment, you will receive a request to “unmute;” please ensure you accept before speaking

Public Comment Opportunities

- Public comment will be taken during the meeting at designated times.
- Public comment will be limited to the total amount of time allocated for public comment on particular issues.
- The Chair will call on individuals in the order in which their hands were raised.
- Individuals will be recognized for up to two minutes and are asked to state their name and organizational affiliation at the top of their statements.
- Participants are encouraged to use the comment box to ensure all feedback is captured or email their comments to CDII@chhs.ca.gov.

Agenda

- 9:30 AM** **Welcome and Introductions**
- *John Ohanian, Chief Data Officer, California Health and Human Services*
- 9:50 AM** **Public Comment**
- 10:05 AM** **The Vision for Data Exchange in California**
- *Dr. Mark Ghaly, Secretary, California Health and Human Services*
- 10:20 AM** **Advisory Group Member Expectations**
- *Dr. Mark Ghaly*
- 10:35 AM** **Overview of Assembly Bill 133**
- *Jared Goldman, General Counsel, California Health and Human Services*
- 10:45 AM** **Advisory Group Purpose and Charter**
- *John Ohanian*
- 11:10 AM** **Break**
- 11:15 AM** **Data Exchange History and Context in California**
- *Dr. Rim Cothren, Consultant to CDII on Data Exchange Framework*
- 11:25 AM** **Data Exchange Framework Issue Prioritization and Measures of Success**
- *Jonah Frohlich, Managing Director, Manatt Health Strategies*
- 11:55 AM** **Closing Remarks**
- *Dr. Mark Ghaly*



Welcome and Introductions

Advisory Group Members

Stakeholder Organizations

Name	Title	Organization
Mark Ghaly (Chair)	Secretary	California Health and Human Services Agency
Jamie Almanza	CEO	Bay Area Community Services
Charles Bacchi	President and CEO	California Association of Health Plans
Bill Barcellona <i>designated by Don Crane</i>	Executive Vice President, Government Affairs	America's Physician Groups
Andrew Bindman <i>designated by Greg A. Adams</i>	Executive Vice President; Chief Medical Officer	Kaiser Permanente
Michelle Doty Cabrera	Executive Director	County Behavioral Health Directors Association of California
Craig Cornett	CEO	California Association of Health Facilities
Carmella Coyle	CEO	California Hospital Association
David Ford <i>designated by Dustin Corcoran</i>	Vice President, Health Information Technology	California Medical Association

Advisory Group Members

Stakeholder Organizations

Name	Title	Organization
Liz Gibboney	CEO	Partnership HealthPlan of California
Michelle Gibbons <i>designated by Colleen Chawla</i>	Executive Director	County Health Executives Association of California
Lori Hack	Interim Executive Director	California Association of Health Information Exchanges
Alma Hernández	Executive Director	Service Employees International Union California
Sandra Hernández	President and CEO	California Health Care Foundation
Linnea Koopmans	CEO	Local Health Plans of California
David Lindeman	Director, CITRIS Health	UC Center for Information Technology Research in the Interest of Society
Paul Markovich	President and CEO	Blue Shield of California
DeeAnne McCallin <i>designated by Robert Beaudry</i>	Director of Health Information Technology	California Primary Care Association

Advisory Group Members

Stakeholder Organizations

Name	Title	Organization
Erica Murray	President and CEO	California Association of Public Hospitals & Health Systems
Art Pulaski	Executive Secretary/Treasurer	California Labor Federation
Karen Relucio	President	California Conference of Local Health Officers
Cary Sanders <i>designated by Kiran Savage-Sangwan</i>	Senior Policy Director	California Pan-Ethnic Health Network
Mark Savage	Managing Director, Digital Health Strategy and Policy	Savage Consulting
Cathy Senderling-McDonald	Executive Director	County Welfare Directors Association
Claudia Williams	CEO	Manifest MedEx
Anthony E. Wright	Executive Director	Health Access California
William York	President and CEO	San Diego Community Information Exchange

Advisory Group Members

State Agencies

CDII would like to thank representatives from the following Departments for joining the Advisory Group

- California Business, Consumer Services and Housing Agency
- California Health Benefit Exchange
- California Public Employees' Retirement System
- Department of Aging
- Department of Corrections and Rehabilitation
- Department of Developmental Services
- Department of Health Care Access and Information
- Department of Health Care Services
- Department of Insurance
- Department of Managed Health Care
- Department of Public Health
- Department of Social Services
- Emergency Medical Services Authority



Public Comment Period



The Vision for Data Exchange in California

Vision for Data Exchange in CA

Before

Siloed and Fragmented Systems and Sectors

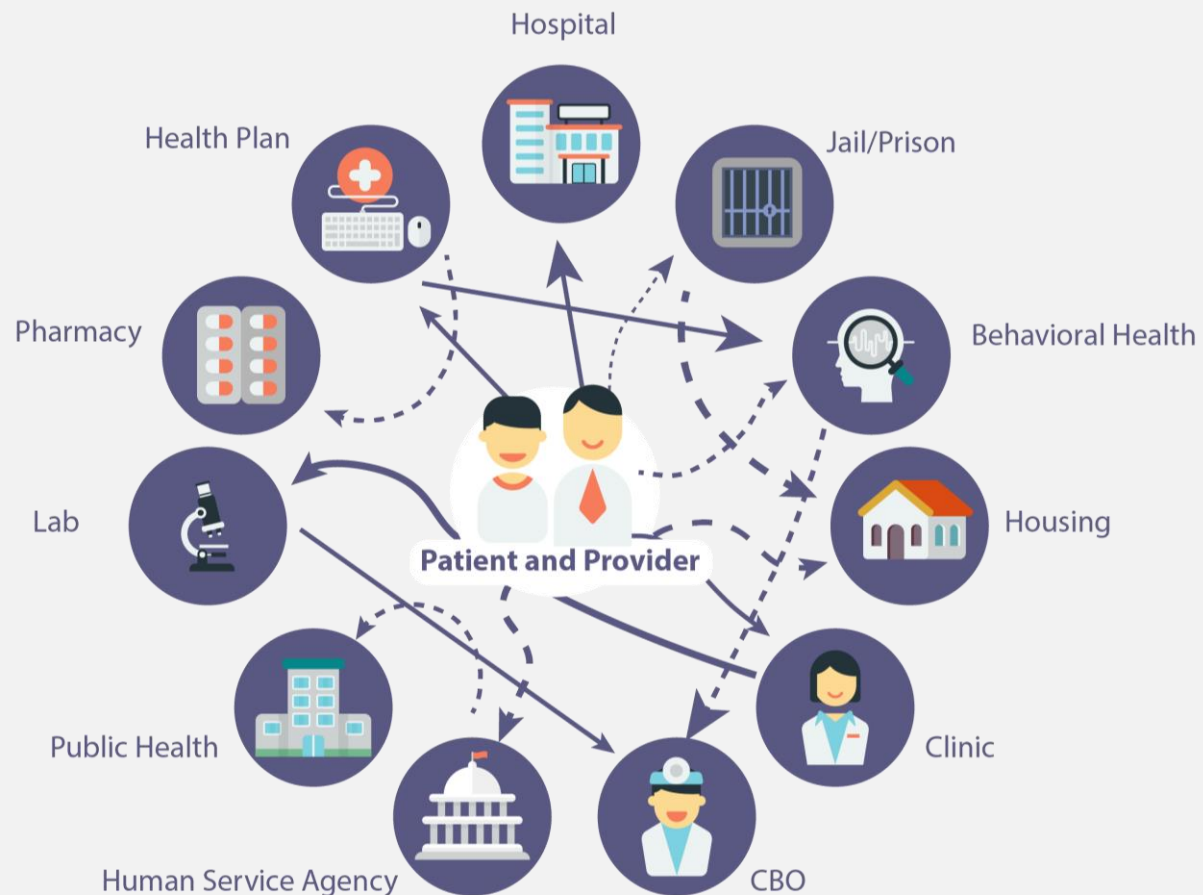

Vision for Data Exchange in CA

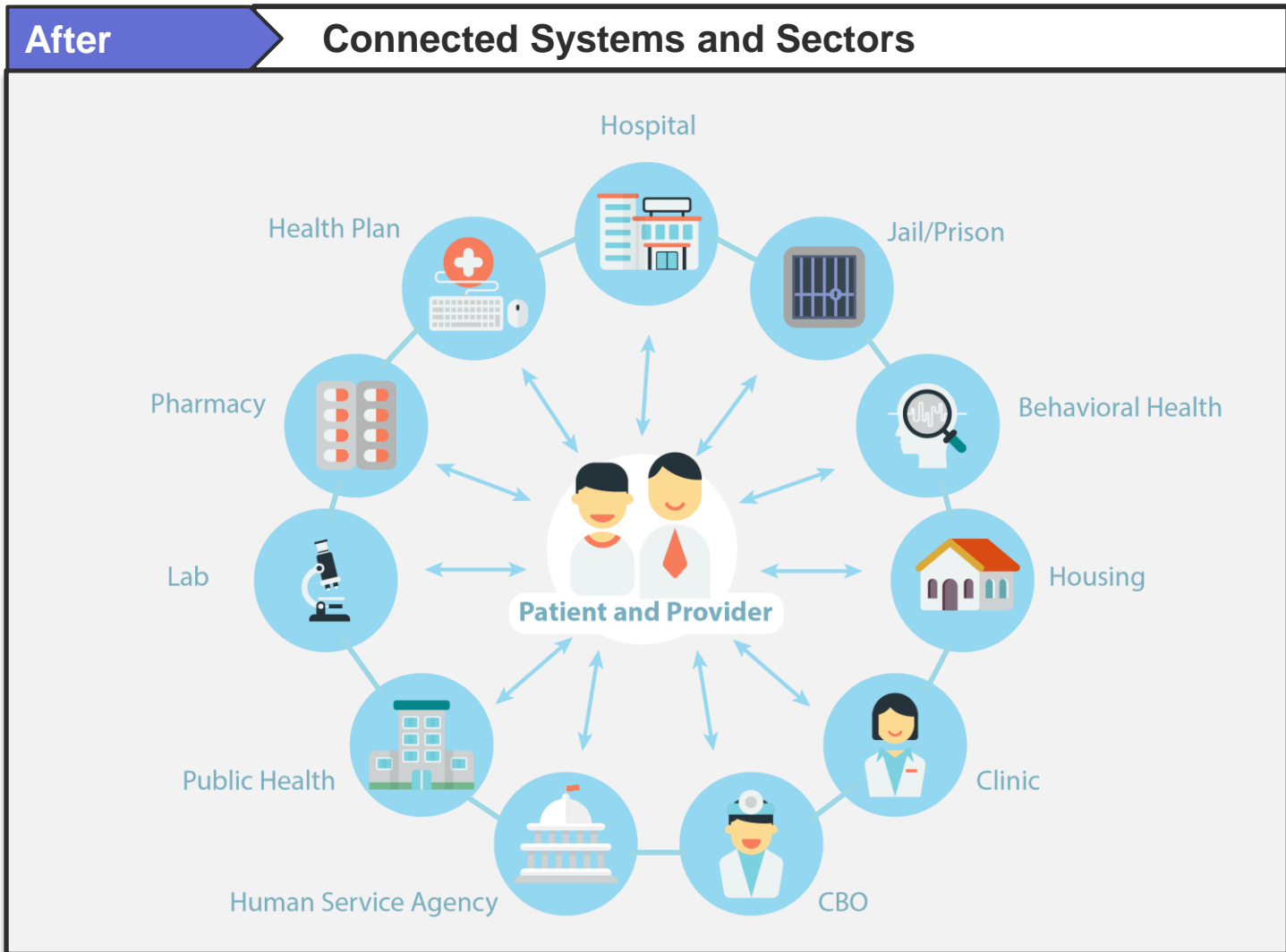

Vision for Data Exchange in CA

Every Californian, and the health and human service providers and organizations that care for them, will have timely and secure access to electronic information that is needed to address their health and social needs and enable the effective delivery of services to improve their lives and wellbeing.



Advisory Group Member Expectations

Agenda

- 9:30 AM** **Welcome and Introductions**
- *John Ohanian, Chief Data Officer, California Health and Human Services*
- 9:50 AM** **Public Comment**
- 10:05 AM** **The Vision for Data Exchange in California**
- *Dr. Mark Ghaly, Secretary, California Health and Human Services*
- 10:20 AM** **Advisory Group Member Expectations**
- *Dr. Mark Ghaly*
- 10:35 AM** **Overview of Assembly Bill 133**
- *Jared Goldman, General Counsel, California Health and Human Services*
- 10:45 AM** **Advisory Group Purpose and Charter**
- *John Ohanian*
- 11:10 AM** **Break**
- 11:15 AM** **Data Exchange History and Context in California**
- *Dr. Rim Cothren, Consultant to CDII on Data Exchange Framework*
- 11:25 AM** **Data Exchange Framework Issue Prioritization and Measures of Success**
- *Jonah Frohlich, Managing Director, Manatt Health Strategies*
- 11:55 AM** **Closing Remarks**
- *Dr. Mark Ghaly*



Overview of Assembly Bill 133

Health and Safety Code § 130290

Overview of Assembly Bill 133

Health and Safety Code § 130290

AB 133 (Chapter 143, Statutes of 2021) signed by Governor Newsom on July 27, enacted Health and Safety Code § 130290, puts California on a path to building a single data sharing agreement that will govern the exchange of health information.

- It requires that CHHS, along with its departments and offices, and in consultation with stakeholders and local partners through an established **Stakeholder Advisory Group**, establish a **Data Exchange Framework** by July 1, 2022 (*see next slide*).
- Section 130290 mandates that a broad spectrum of health care organizations execute the Framework's data sharing agreement by January 31, 2023, and exchange or provide access to health information with other mandated organizations by January 31, 2024.
- Section 130290 also requires CHHS to submit written recommendations to the Legislature based on input from the Advisory Group on or before April 1, 2022 and publish a Strategy for Digital Identities by July 31, 2022.

Data Exchange Framework

Section 130290 Requirements

The Data Exchange Framework will include:

- A single data sharing agreement; and
- A common set of policies and procedures that will leverage and advance national standards for information exchange and data content that will govern and require the exchange of health information among health care entities and government agencies in California.

The Data Exchange Framework will:

- Be designed to enable and require real-time access to, or exchange of, health information among health care providers & payers through:
 - Any health information exchange network
 - Health information organization, or
 - Technology that adheres to specified standards and policies
- Be aligned with other state and federal data exchange standards and requirements



Advisory Group Purpose and Charter

Advisory Group Charter

Purpose and Expectations

Advisory Group Purpose

Advise CHHS in its development and implementation of a statewide Health and Human Services Data Exchange Framework that will govern the exchange of health information among health care entities and government agencies by January 31, 2024.

Member Expectations

Stakeholder Advisory Group members may assign a “designee” to represent them and their organization at meetings. Designees will fulfill all member responsibilities, including regularly attending and participating in meetings.

Members will be expected to:

- Consistently attend and actively participate in meetings;
- Inform the Chair/staff if they are unable to attend a meeting;
- Review shared materials in advance of each meeting;
- Keep statements respectful, constructive, relevant, and brief;
- Be solutions-oriented in their deliberations and comments; and
- Provide input on draft materials, as requested.

Advisory Group Charter

Member Expectations

Member Expectations (Continued)

Stakeholder Advisory Group members have been selected for their expertise and will serve in an important advisory role to CHHS on data exchange matters and provide input on policy recommendations. The **Stakeholder Advisory Group advises and advances recommendations** to the Secretary of the CHHS Agency and does not have decision-making authority.

The Stakeholder Advisory Group will **meet approximately monthly from August 2021 through June 2022.**

The Stakeholder Advisory Group will **conduct its business through discussion and consensus building**, identifying and documenting key considerations of various Data Exchange Framework recommendations that are advanced to the CHHS Secretary for consideration. CHHS may establish additional procedural processes as needed.

Advisory Group Charter

CHHS and Chair Roles

CHHS

- **Develop and publish required deliverables** (e.g., Legislative Report, Legislative Update, the Framework, Digital Identities Strategies)
- **Consult and facilitate the Advisory Group** on key topics, solicit recommendations, develop meeting materials, and draft meeting summaries

Chair

- **Presides** over Advisory Group meetings
- **Coordinates meeting agendas** with designated support staff
- **Reviews and approves draft meeting summaries**

Subcommittees

The Stakeholder Advisory Group may be supported by subcommittees. Established subcommittees will comprise stakeholders with relevant expertise; members will be appointed by CHHS.

Charter Approval

- Are there any recommended amendments to the proposed Stakeholder Advisory Group Charter, as drafted?
- Does the Stakeholder Advisory Group recommend approval of the charter to guide our activities and deliberations, as outlined by AB 133 Section 130290?



Break (5 min.)

Agenda

- 9:30 AM** **Welcome and Introductions**
- *John Ohanian, Chief Data Officer, California Health and Human Services*
- 9:50 AM** **Public Comment**
- 10:05 AM** **The Vision for Data Exchange in California**
- *Dr. Mark Ghaly, Secretary, California Health and Human Services*
- 10:20 AM** **Advisory Group Member Expectations**
- *Dr. Mark Ghaly*
- 10:35 AM** **Overview of Assembly Bill 133**
- *Jared Goldman, General Counsel, California Health and Human Services*
- 10:45 AM** **Advisory Group Purpose and Charter**
- *John Ohanian*
- 11:10 AM** **Break**
- 11:15 AM** **Data Exchange History and Context in California**
- *Dr. Rim Cothren, Consultant to CDII on Data Exchange Framework*
- 11:25 AM** **Data Exchange Framework Issue Prioritization and Measures of Success**
- *Jonah Frohlich, Managing Director, Manatt Health Strategies*
- 11:55 AM** **Closing Remarks**
- *Dr. Mark Ghaly*



Data Exchange History and Context in California

Types of Data Exchange

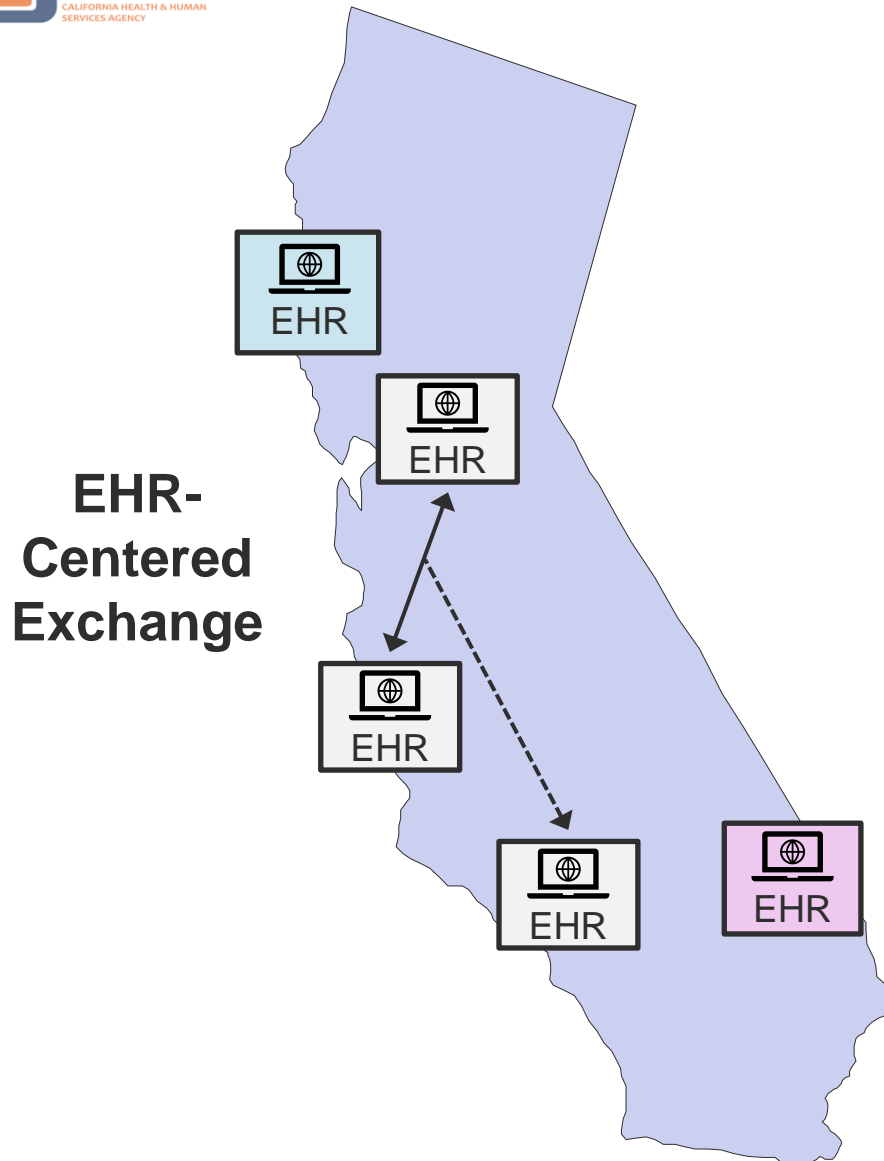

Types of Data Exchange

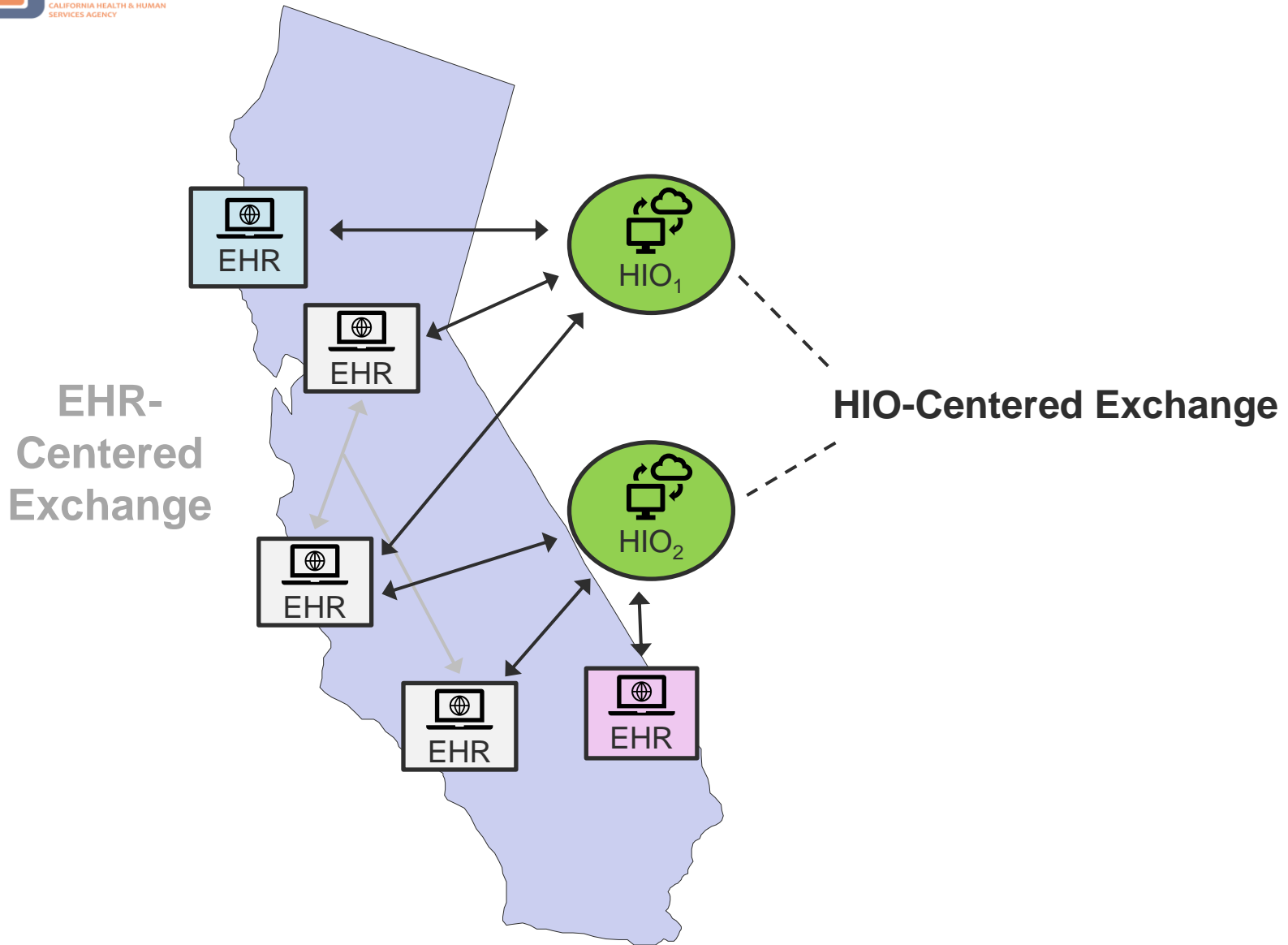

Types of Data Exchange

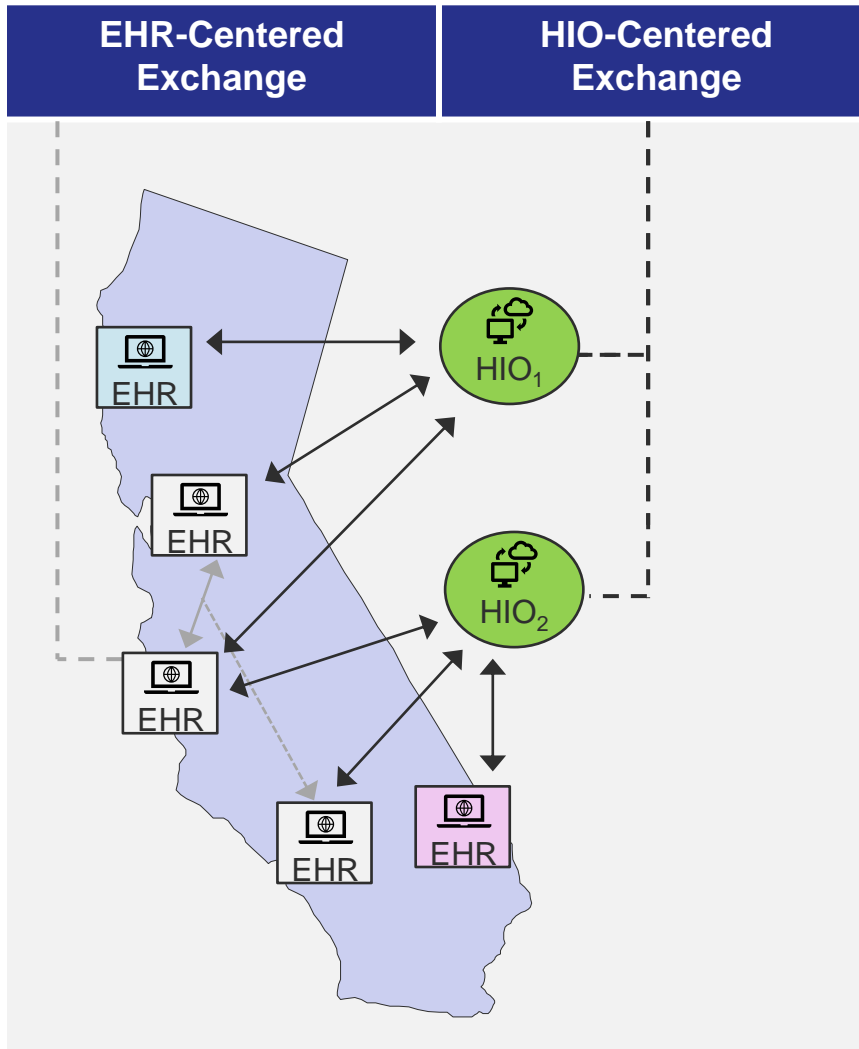

Types of Data Exchange

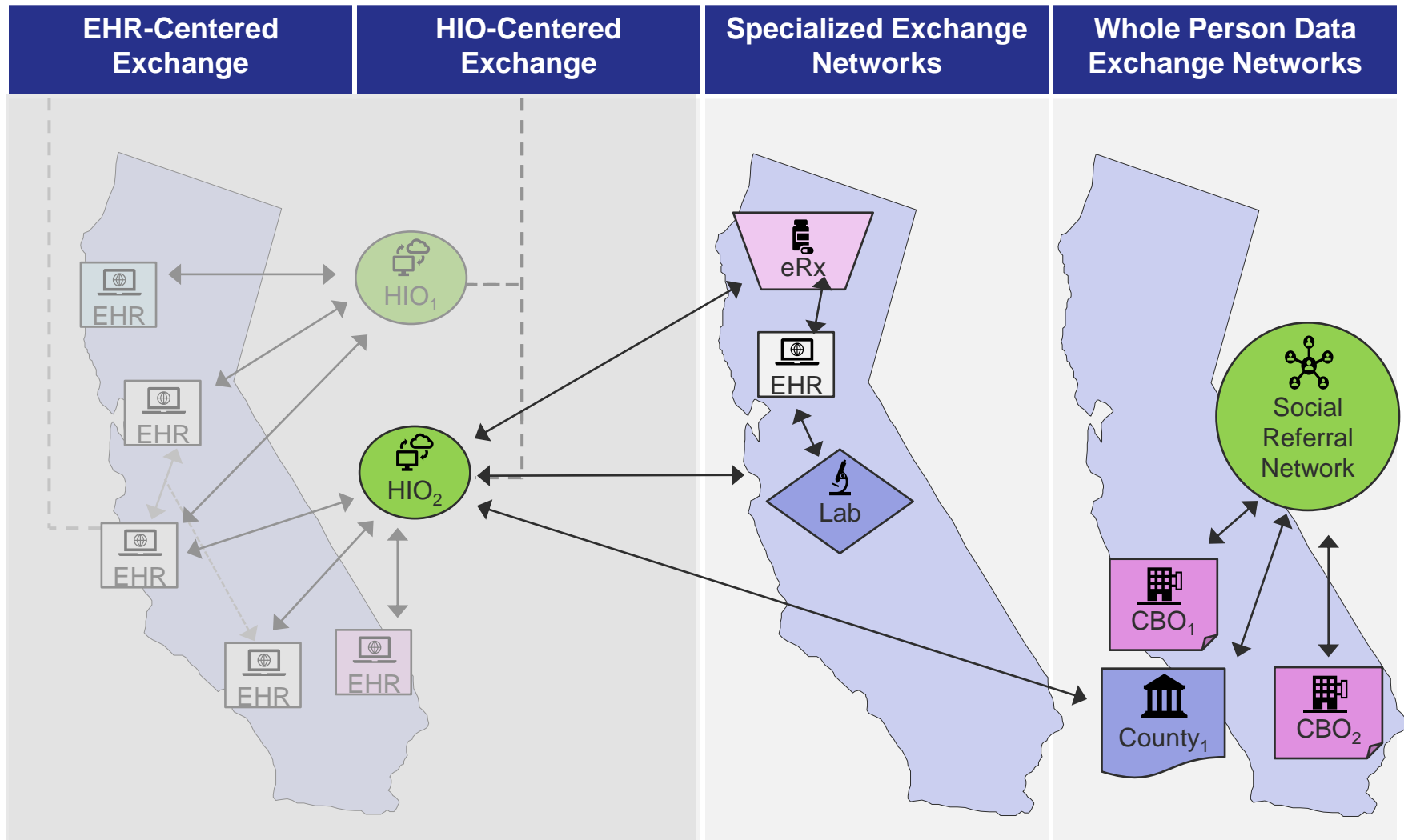

An Abridged

Data Exchange History in California

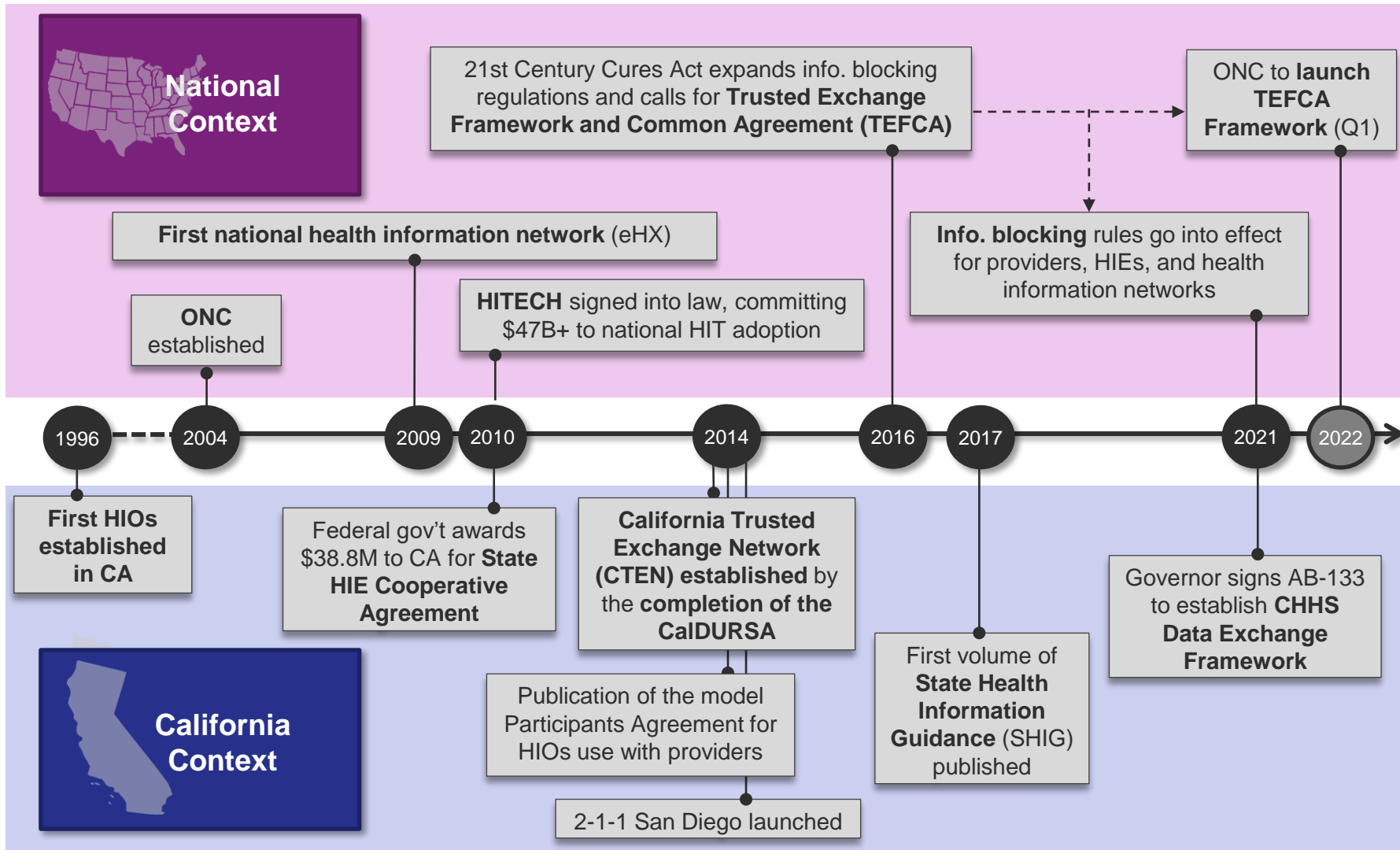

Note: Additional information available at [A Timeline of Health Data Exchange in California](#)

California Trusted Exchange Network (CTEN)

What is it?

Voluntary self-governance of exchange; collaborative effort of participating organizations

CaIDURSA

Multiparty data sharing agreement consistent with nationwide networks

Policies and Practices

Consensus standards for decision- and policy-making, onboarding, testing, obligations, enforcement, etc.

Who participates?

Signatories

19 organizations have executed the CaIDURSA

Governance

15 organizations participate in governance

Exchange

16 organizations actively exchange data:

- 11 community HIOs
- 3 health systems
- 2 departments of CHHS

How is it used?

Applicable to treatment, payment, health care operations, or public health purpose for use

Use Cases

- Care coordination among providers
- PULSE emergency response system

Participation sometimes used in state programs as a commitment to share health information with others

Learning from History

What lessons have we learned from our health information exchange experience that should guide this work?



Data Exchange Framework

Issue Prioritization and Measures of Success

Advisory Group Member Reflections: Goals

Survey Question: *What do you hope the Advisory Group will accomplish?*

Select Responses

*“Having a **consumer-centered approach** is foundational, thinking of it as the patient’s record, not a doctor’s work product...how a patient would have access to their record, and how a system would allow them to engage with it, including enabling to go out-of-network or region or otherwise.”*

*“Overarching goal in participating in this process is to have **every physician in this state have access to all of the information they need to provide the best possible care to their patients.**”*

*“The advisory group should focus on efforts to **strengthen and expand data sharing in California that preserves and builds off of infrastructure at the local level, without being duplicative.**”*

*“A statewide mandate for there to be accessible, congruent, **NON-DUPLICATIVE, data systems that cross all sectors - homeless/BH/SUD/health/Social.**”*

*“Safely and securely **share Health Care Data among the various government entities** to provide continuity of care and research”*

*“Success for the Advisory Group means an agreement to cast the Data Exchange Framework as a **comprehensive health record that is available for every person.**”*

Based on responses received as of August 27, 5PM PT.

Advisory Group Member Reflections: Goals

Survey Question: *What do you hope the Advisory Group will accomplish?*

Priority Goal Themes

- Develop **standard statewide HIE objectives and priority use cases**
- Develop policies to **improve access to information that is needed to drive quality of care and health outcome improvements** across the population
- **Identify and close gaps in data exchange** for sectors that are not extensively participating in HIE networks
- **Address disparities and health equity** by developing clear state guidance on how demographic and other related data should be collected and shared
- Develop strategies to **leverage and expand existing data exchange capabilities, infrastructure and networks** at the local, state & national level
- Develop policies to **protect patient privacy** and confidentiality.

Advisory Group Member Reflections: Barriers to Overcome

Survey Question: *Please describe the key data exchange barriers that your organization and/or stakeholders face.*

Select Responses

*“Currently, **workers are still using fax machines** to send and receive patient records. Our current antiquated and haphazard system leaves the care team searching for data when minutes are the difference between life and death.”*

*“**Many small practice physicians...utilize less-robust [EHR] systems** that do not have adequate or supported electronic data exchange capability as compared to the larger, more robust EHR systems.”*

*“**Policy--especially for mental health records Financing/Technical-...at state level and at health system/provider level**”*

*“**Data governance and ownership** is a critical consideration”*

*“**The confusion around state and federal rules and regulations around consent, privacy, and security** causes uncertainty and fear resulting in lack of process, particularly in behavioral health. Further, **existing regulations need to be updated to align with the current electronic and technological possibilities** and sector capacities.”*

*“**Overcoming a culture of information blocking and delay and promoting a culture of information sharing and coordination.**”*

Advisory Group Member Reflections: Barriers to Overcome

Survey Question: *Please describe the key data exchange barriers that your organization and/or stakeholders face.*

Barrier Themes

- **Fragmentation of data sources** limits the availability a comprehensive health record for all patients.
- **Reliance on EHRs and national networks** limits the comprehensiveness of data exchange with limited connections with payers, behavioral health and social service providers, and public health & social service agencies.
- **Antiquated HIE infrastructure** among stakeholders, particularly smaller providers.
- **Misaligned - and often confusing - laws, policies, and standards** around medical and health-determining data sharing and access.
- **Business practices** that restrict the availability of data.
- **Financial and technical “barriers to entry”** for certain types of providers.

Advisory Group Member Reflections: Issue Prioritization

Survey Question: *What areas of data exchange are the most important to prioritize at the outset of the Advisory Group's work on the Framework?*

Number of Members Ranking Topic as Among the Top 3 Most Important

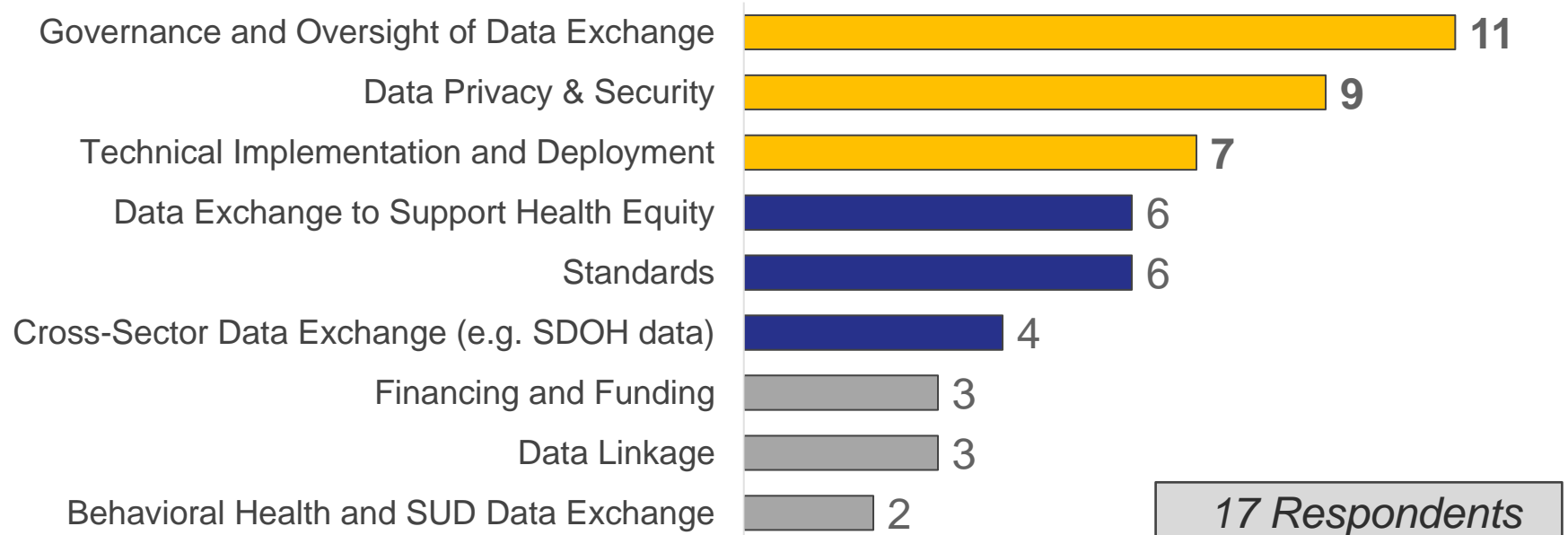

Data Exchange Framework Topics

Section 130290 requires these topics to be incorporated into the Framework

How should the Advisory Group triage and address these topics?

- Consideration of Various Data Types, including:
 - Behavioral Health and Substance Use Disorder Data
 - Social Determinants of Health Data
 - Data Related to Underserved/Underrepresented Pops.
- Gaps in Health Information Life Cycle
- Strategy for unique, secure digital identities
- Payer Requirements
- Governance
- Funding
- Privacy, Security, and Equity Risks
- Policies and Procedures
- Definitions and Standards

*Topics requiring
subject matter
expertise to draft
recommendations*

*Topics for the Advisory Committee
to address directly*

*Topics to be incorporated into the
data sharing agreement*

Data Sharing Agreement Development

CHHS is expected to develop a “single data sharing agreement” to facilitate statewide and potentially cross-sector data sharing

The data sharing agreement should build on the CalDURSA ([website](#)), previous guidance from the state and SHIG ([website](#)), TEFCA ([website](#)), and be developed to align with:

- Health Insurance Portability and Accountability Act of 1996 (HIPAA Public Law 104-191);
- Confidentiality of Medical Information Act of 1996 (CMIA - Part 2.6 [commencing with Section 56] of Division 1 of the Civil Code); and
- Other applicable state and federal privacy laws and guidance related to the sharing of data among and between providers, payers, and the government.

Discussion Questions:

Would the Advisory Group recommend the formation of a subcommittee to develop a draft data sharing agreement?

Next Steps

CHHS will:

- Summarize meeting notes and circulate for review over email in advance of next meeting.
- Propose, based on today's feedback:
 - Goals and principles to guide the Stakeholder Advisory Group's efforts;
 - A workplan; and
 - Subcommittee(s) to advance specific products or topics (e.g., data sharing agreement, identity management strategy).
- Schedule Stakeholder Advisory Group meetings through June 2022.

Members will:

- Review meeting notes and provide feedback to CHHS staff.
- Confirm availability for Stakeholder Advisory Group meetings through June 2022 (including permanent delegates, where necessary).



Closing Remarks

Advisory Group Meeting Schedule

Meeting	Date
Advisory Group Meeting #1	August 31, 2021, 9:30 AM to 12:00 PM
Advisory Group Meeting #2	~ <i>October 7, 2021, 10:00 AM to 12:30 PM</i>

For more information or questions on Advisory Group meeting scheduling and logistics, please email Kevin McAvey (Kmcavey@manatt.com).

Thank You!